

# S-T INDUSTRIES, INC.

S C H E R R - T U M I C O

## Optical Comparators

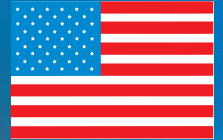

MADE IN U.S.A.

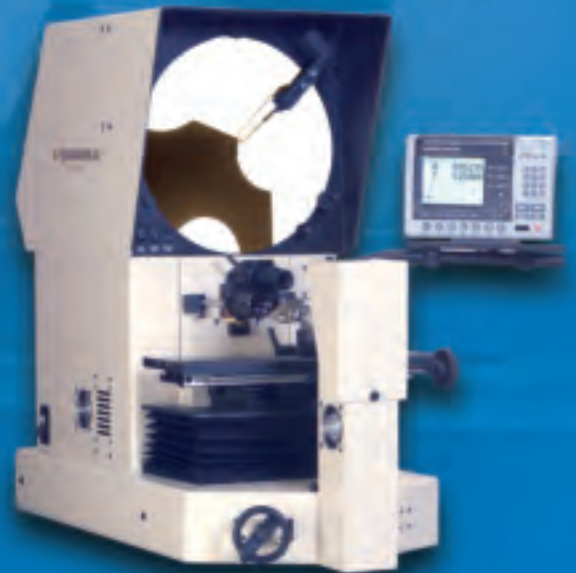

### RFM

Resources For Manufacturing, Inc.

See the  
Quality

## HORIZONTAL COMPARATORS

<b>3500/3550</b>	<b>14" SERIES</b> .....	<b>1</b>
<b>3700</b>	<b>14" SERIES</b> .....	<b>2</b>
<b>1600</b>	<b>16" SERIES</b> .....	<b>3</b>
<b>2450</b>	<b>24" SERIES</b> .....	<b>4</b>
<b>2460</b>	<b>24" SERIES</b> .....	<b>5</b>
<b>2600</b>	<b>30" SERIES</b> .....	<b>6</b>
<b>5600</b>	<b>30" SERIES</b> .....	<b>7</b>
<b>REMANUFACTURED 30" COMPARATORS</b> .....		<b>10-11</b>

## VERTICAL COMPARATORS

<b>4600</b>	<b>14" SERIES</b> .....	<b>8</b>
<b>2400</b>	<b>24" SERIES</b> .....	<b>9</b>

## FIXTURES AND CHARTS

<b>FIXTURES</b> .....	<b>12-14</b>
<b>SCREENS AND CHARTS</b> .....	<b>15-17</b>
<b>COMPARATOR CALIBRATION KITS</b> .....	<b>18</b>
<b>CONSOLE BASES</b> .....	<b>19</b>
<b>LENS FOCAL CLEARING CHART</b> .....	<b>20</b>
<b>QUADRA CHEK DIGITAL READOUTS</b> .....	<b>21</b>

## The S-T Industries Story

Since 1942, S-T Industries, Inc. has been producing fine measuring instruments. From micrometers to optical comparators, the SCHERR-TUMICO name continues to be a hallmark of quality around the world. When S-T introduced the Model 1500 vertical beam optical comparator in the 1950s, it allowed companies of all sizes to afford the technology of profile projection. As we look forward to the 21st century, S-T Industries is committed to providing high-quality products for metrology at reasonable prices.

## Quality

Every SCHERR-TUMICO optical comparator and video inspection system receives a thorough inspection and certification before it leaves our factory. This assures you there will be no surprises at your factory. These products are hand-built and tested through each step of the process to guarantee that you will receive a reliable and proven instrument.

## Performance

SCHERR-TUMICO optical comparators and video inspection systems are designed to give you the best value for your investment. We have a unit for any job or budget. From small, economical machines to large, CNC measuring systems, you'll find we have just the right product to fit your needs. We'll even modify an existing system if we don't have exactly what you want.

## Innovation

S-T Industries has incorporated many unique features into its products. Among them are our exclusive Gothic arch ballways, which provide the ultimate in accuracy, strength and durability. Also, our 30" comparators are portable. They are equipped with large casters so that one person can move the instrument. And, our CNC products all have a digital positioning system that allows table movements of 1 micron. We will continue to add new ideas and technology to our products, because at S-T Industries, our design engineer is our customer.

## International Operations

SCHERR-TUMICO optical comparators and video inspection systems are available throughout the industrialized world. S-T Industries maintains a service and distribution network with factory qualified sales and service representatives in the following countries. Call or write for your representative.

Australia	Canada	China	Denmark
Germany	Great Britain	Holland	Hong Kong
India	Indonesia	Ireland	Israel
Malaysia	Mexico	Norway	Pakistan
Philippines	Scotland	Singapore	South Africa
South America	South Korea	Sweden	Taiwan
Thailand	Turkey		

SCHERR-TUMICO for Quality, Service and Value

## Service and Warranty

All S-T Industries Optical Comparators and Video Inspection Systems include a two-year warranty on parts and labor, installation and training at your facility, and a certificate to NIST. There are no additional hidden costs for this service.

# 3500

The "3500" Series 14" benchtop horizontal beam is the perfect general purpose optical comparator. Its high accuracy and compact size make it the choice of even the most demanding user. The unique, granite-like housing offers a rugged appearance to this fine instrument. The stage features hardened and precision ground bearing ways.

- High precision 4" x 10" travel measuring stage with .00005"/.001mm resolution precision glass scales. Quick release with fine adjust on X-axis. 50-lb load capacity.
- Choice of all QuadraChek® digital readouts. See page 21.
- Quick change mount for factory preset magnification lenses.
- Hardened steel, nickel-plated workstage for long life and corrosion resistance.
- Tungsten/halogen profile illumination for bright, sharp images at all magnifications.
- Duplex fiber optic surface illumination.
- Vernier Screen Protractor reading to 5'.
- Optional digital screen protractor with readings to 1' or .01°.
- Helix +/- 6° via lamphouse displacement.
- Heavy-duty steel chassis.
- Fully useable 14" diameter screen.



## Specifications

**Measuring Stage Resolution:** .00005"/.001 mm  
**Measuring Travel:** 10" (250 mm) horizontal (X), 4" (100 mm) vertical (Y), 2.5" (60 mm) focus with quick release on x-axis  
**Precision Measuring Stage:** 5" x 16" (125 x 400 mm) nickel-plated top plate  
**Digital Screen Protractor on 3500 Series:** angular readings to 1 minute or .01° of arc  
**Duplex Fiber Optic Surface Illumination**  
**14" Frosted Glass Screen:** with 30-, 60- and 90-degree crosslines  
**Helix:** +/- 6° via lamphouse displacement  
**Heavy-Duty Dust Cover**

- Steel construction with Polyethylene body
- 50 lb (22 kg) allowable workload on stages

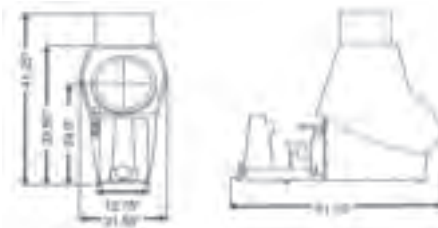

- Electrical: 115/220 V, 50/60 Hz, Single Phase, 2.0 Amp
- Approx. Weight: Net 200 lb (91 kg) - Crated 330 lb (150 kg)

## Magnification Lenses

### OPTIONAL MAGNIFICATION LENSES

- |  |                         |
|--|-------------------------|
| • 5x Magnification                           | • 31 1/4x Magnification |
| • 10x Magnification                          | • 50x Magnification     |
| • 10x Magnification with long focal distance | • 62 1/2x Magnification |
| • 20x Magnification                          | • 100x Magnification    |
| • 20x Magnification with long focal distance | • 250x Magnification    |
| • 25x Magnification                          |                         |

# 3700



This is our top-of-the-line 14" benchtop horizontal beam optical comparator. The 3700 is the ultimate system for load capacity and accuracy. It features an erect image and S-T's exclusive Gothic arch bearing ways which provide the best in accuracy and longevity.

- Erect image.
- High precision 6" x 12" measuring stage travel with .00005"/.001 mm resolution precision glass scales. Quick release with fine adjust on X-axis. Optional 5" x 16" travel. 100-lb load capacity.
- Choice of all QuadraChek® digital readouts. See page 21.
- Standard 2-lens turret system.
- Hardened steel, nickel-plated workstage for long life and corrosion resistance.
- Helix +/- 6° via lamphouse displacement.
- Heavy-duty all-steel construction.
- Fully useable 14" diameter screen.
- Standard swingaway lamphouse.
- Duplex fiber optic surface illumination.
- Digital screen protractor with readings to 1' or .01°.
- Available motorized joystick control and CNC option.

## Specifications

**Work Table:** 5" x 20" (125 mm x 500 mm) w/2 clamping slots

**Measuring Travel:** 12" (300 mm) (X), 6" (150 mm) (Y),  
2.5" (60 mm) Focus  
Optional 16" Horiz. Travel

**Measuring Stage Resolution:** .00005"/.001 mm

**Allowable Work Load:** 100 lb (45 kg)

**Two-Lens Turret**

**Digital Screen Protractor:** 1 min/.01° arc

**Duplex Surface Illumination**

**Helix:** +/- 6° via lamphouse displacement

**14" Frosted Glass Screen:** with 30-, 60- and 90-degree crosslines

**Electrical:** 115/220 V, 50/60 Hz

**Weight:** Net 325 lb (145 kg) - Crated 465 lb (206 kg)

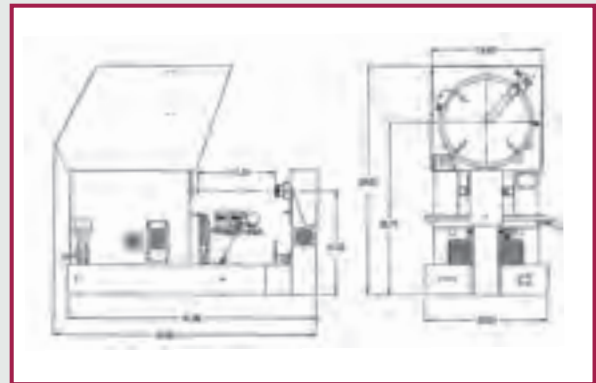

## Magnification Lenses

### OPTIONAL MAGNIFICATION LENSES

- 5x Magnification
- 10x Magnification
- 10x Magnification with long focal distance
- 20x Magnification
- 20x Magnification with long focal distance
- 25x Magnification
- 31 1/4x Magnification
- 50x Magnification
- 62 1/2x Magnification
- 100x Magnification
- 250x Magnification



The "1600" Series 16" benchtop horizontal beam optical comparator sets a new world standard for 16" comparators, with extra heavy-duty all-steel construction and a large-capacity measuring stage with a superior gothic arch bearing way system.

- High precision 5" x 20" stage with 7" x 12" travel, optional 7" x 16" travel, .00005"/.001 mm resolution glass scales and a 150-lb load capacity.
- Hardened steel, nickel-plated workstage for long life and corrosion resistance.
- Digital screen protractor to 1' or .01°.
- Duplex fiber optic surface illumination.
  - +/- 15° helix on stage.
  - Erect image.
- Standard swingaway lamphouse.
- Long life tungsten/halogen bulbs.
- Optional 2-lens turret.
  - Exclusive Gothic arch bearing ways on stage.
  - Choice of all QuadraChek® digital readouts. See page 21.
  - Available motorized joystick controls and full CNC.

## Specifications

**Work Table:** 5" x 20" (125 mm x 500 mm)  
**Measuring Range:** 7" x 12" (175 mm x 300 mm)  
Optional 7" x 16" (175 mm x 400 mm)  
**Allowable Work Load:** 150 lb (65 kg)  
**Illumination:** Profile - 150 W, Surface - 150 W x 2  
**Focus Travel:** 3" (75 mm)  
**Screen Size:** 16" (400 mm)  
**Helix:** +/- 15°, workstage vernier  
**Electrical:** 100/240 V, 50/60 Hz  
**Weight:** 500 lb (225 kg) - Crated 600 lb (270 kg)

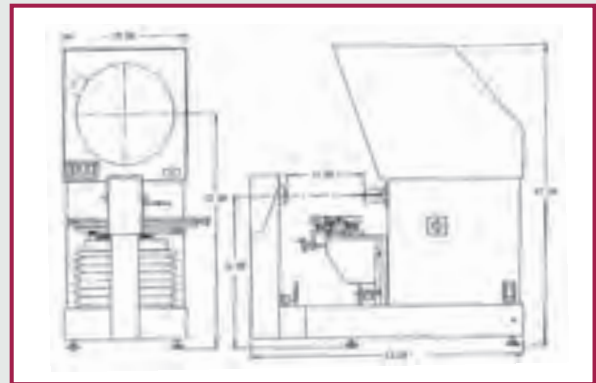

## Magnification Lenses

### OPTIONAL MAGNIFICATION LENSES

- 5x Magnification
- 10x Magnification
- 20x Magnification
- 25x Magnification
- 31<sup>1</sup>/<sub>4</sub>x Magnification
- 50x Magnification
- 62<sup>1</sup>/<sub>2</sub>x Magnification
- 100x Magnification

# 2450

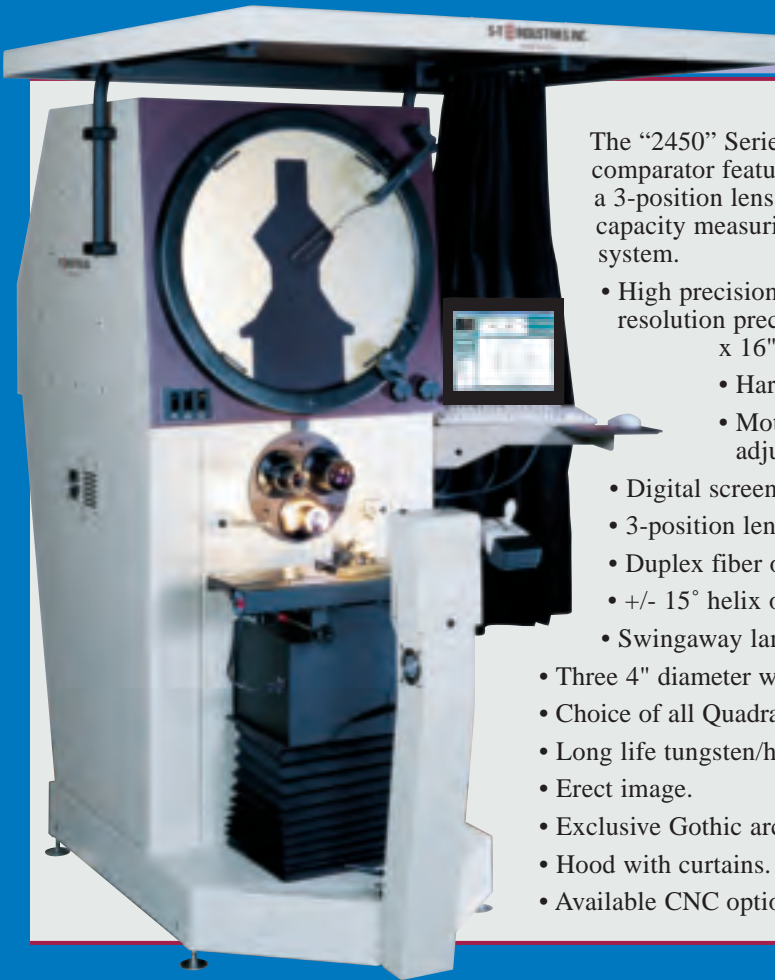

The "2450" Series 24" floor model erect image horizontal beam optical comparator features a rugged structure, an 8" x 12" travel measuring stage, a 3-position lens turret, extra heavy-duty all-steel construction and a large capacity measuring stage with an exclusive Gothic arch bearing way system.

- High precision 5" x 24" stage with 8" x 12" travel, .00005"/.001 mm resolution precision glass scales and a 200-lb load capacity, optional 8" x 16" travel.
- Hardened steel, nickel-plated workstage.
- Motorized X and Y axis with joystick controls and X-Y fine adjust jog wheels.
- Digital screen protractor to 1' or .01°.
- 3-position lens turret.
- Duplex fiber optic surface illumination.
- +/- 15° helix on stage.
- Swingaway lamphouse.
- Three 4" diameter wheels for portability.
- Choice of all QuadraChek® DROs. See page 21.
- Long life tungsten/halogen bulbs.
- Erect image.
- Exclusive Gothic arch bearing ways on stage.
- Hood with curtains.
- Available CNC options.

## Specifications

**Work Table:** 5" x 24" (125 mm x 600 mm)  
**Measuring Range:** 8" x 12" (200 mm x 300 mm)  
Optional 8" x 16" (200 mm x 400 mm)  
**Allowable Work Load:** 200 lb (90 kg)  
**Helix:** +/- 15°, workstage vernier  
**Illumination:**  
Profile - 150 W  
Duplex Surface - 150 W x 2  
**Focus Travel:** 3" (75 mm)  
**Screen Size:** 24" (600 mm)  
**Floor Space:** 31" x 64" (785 x 1625 mm)  
**Electrical:** 100/240 V, 50/60 Hz  
**Weight:** 1100 lb (500 kg) - Crated 1300 lb (590 kg)

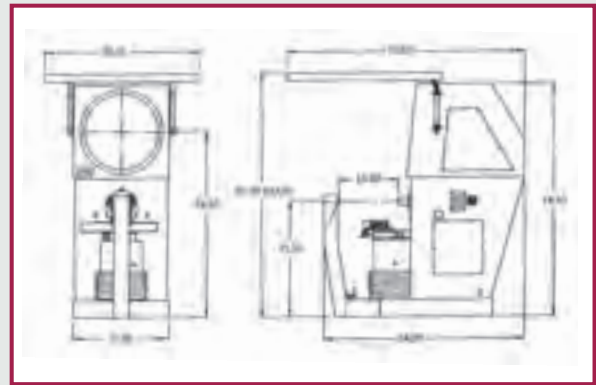

## Magnification Lenses

### OPTIONAL MAGNIFICATION LENSES

- 5x Magnification
- 10x Magnification
- 20x Magnification
- 25x Magnification
- 31<sup>1</sup>/<sub>4</sub>x Magnification
- 50x Magnification
- 62<sup>1</sup>/<sub>2</sub>x Magnification
- 100x Magnification

# 2460



The "2460" Series 24" floor model inverted image horizontal beam optical comparator features a rugged structure, an 8" x 12" travel measuring stage, extra heavy-duty all-steel construction and a large capacity measuring stage with a superior Gothic arch bearing way system.

- High precision 5" x 24" stage with 8" x 12" travel, .00005"/.001 mm resolution precision glass scales and a 200-lb load capacity, optional 8" x 16" travel.
- Motorized X and Y axis with joystick controls and X-Y fine adjust jog wheels.
- Hardened steel, nickel-plated workstage.
- Digital screen protractor to 1' or .01°.
- Single lens mount.
- Duplex fiber optic surface illumination.
- +/- 15° helix on stage.
- Swing away lamphouse.
- Choice of all QuadraChek® DROs. See page 21.
- Long life tungsten/halogen bulbs.
- Inverted image.
- Exclusive Gothic arch bearing ways on stage.
- Hood with curtains.
- Three 4" diameter wheels for portability.
- Available CNC options.

## Specifications

**Work Table:** 5" x 24" (125 mm x 600 mm)  
**Measuring Range:** 8" x 12" (200 mm x 300 mm)  
Optional 8" x 16" (200 mm x 400 mm)  
**Allowable Work Load:** 200 lb (90 kg)  
**Helix:** +/- 15°, workstage vernier  
**Illumination:** Profile - 150 W, Surface - 150 W x 2  
**Focus Travel:** 3" (75 mm)  
**Screen Size:** 24" (600 mm)  
**Floor Space:** 31" x 68.25" (785 mm x 1734 mm)  
**Electrical:** 100/240 V, 50/60 Hz  
**Weight:** 1000 lb (455 kg) - Crated 1200 lb (545 kg)

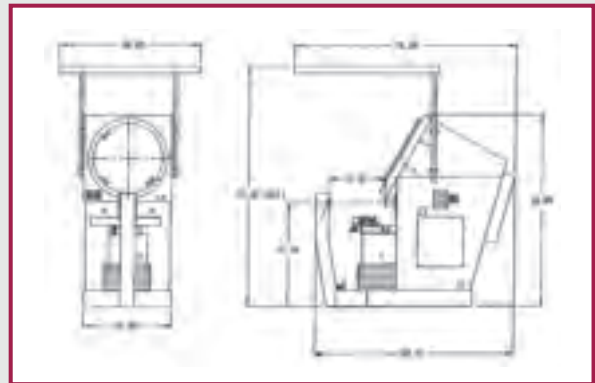

## Magnification Lenses

### OPTIONAL MAGNIFICATION LENSES

- 5x Magnification
- 10x Magnification
- 20x Magnification
- 25x Magnification
- 31<sup>1</sup>/<sub>4</sub>x Magnification
- 50x Magnification
- 62<sup>1</sup>/<sub>2</sub>x Magnification
- 100x Magnification

# 2600

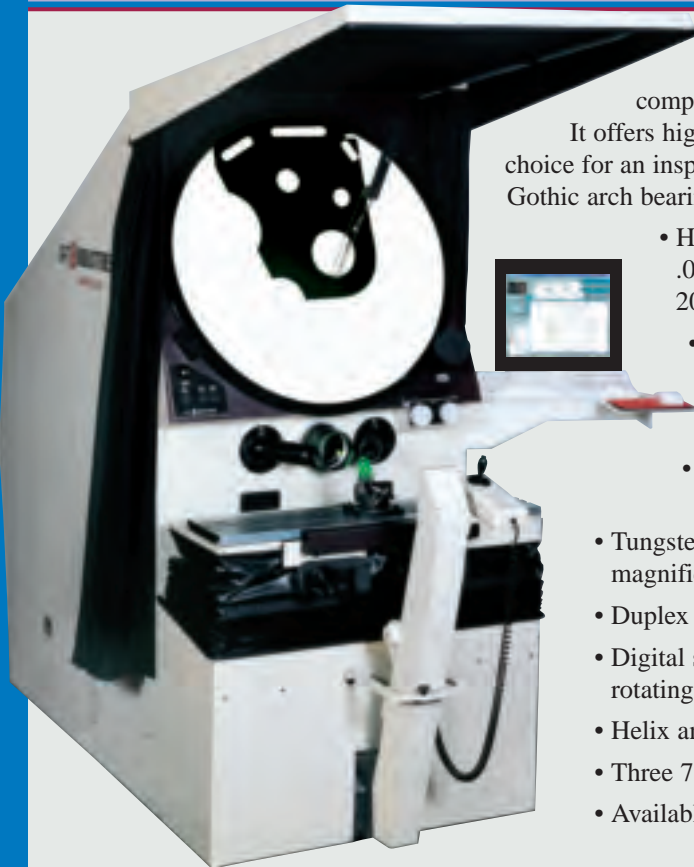

The "2600" Series 30" floor model horizontal beam optical comparator has been a leader in the industry for over 40 years.

It offers high accuracy and weight capacity in a portable package, making it a choice for an inspection room or shop floor application. It features S-T's exclusive Gothic arch bearing ways which provide the best in accuracy and longevity.

- High precision 9" x 12" measuring stage travel with .00005"/.001 mm resolution precision glass scales. Optional 7" x 20" and 7" x 24" travels available.
- Motorized X and Y axis with joystick control.
- Choice of all QuadraChek® digital readouts. See page 21.
- Optional 6-position power lens changer.
- Hardened steel, chrome-plated workstage for long life and corrosion resistance.
- Tungsten/halogen profile illumination for bright, sharp images at all magnifications.
- Duplex adjustable surface illumination.
- Digital screen protractor with readings to 1' or .01° with rotating steel ring.
- Helix angle +/- 10° by swinging lamphouse.
- Three 7" diameter wheels for portability.
- Available CNC option.

## Specifications

**Measuring Travel:** 9" x 12" (225 mm x 300 mm)

Larger travels available

**Work Table:** 8" x 35", hardened steel, chrome-plated

**Focus Travel:** 3"

**Allowable Work Load:** 500 lb

**Gothic Arch Hardened Steel Bearing Ways**

**Stage Motion:** Motorized 2-axis variable speed joystick

**Measuring Stage Resolution:** .00005"/.001 mm

**Digital Screen Protractor:** 1 min/.01° arc

**Duplex Adjustable Surface Illumination**

**30" Frosted Glass Screen:** with 30-, 60- and 90-degree crosslines

**Helix:** +/- 10° by swinging lamphouse

**Mounted on Three 7" Wheels for Portability**

**Electrical:** 115 V, 60 Hz; other voltages available.

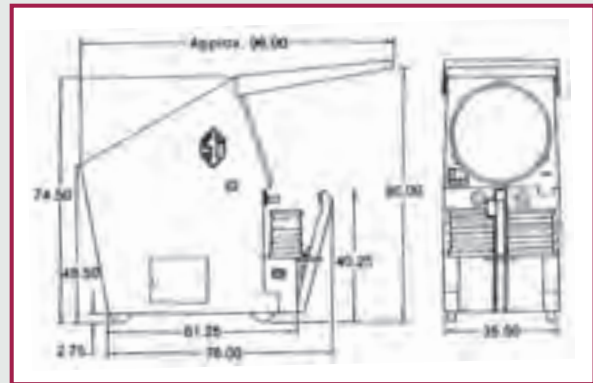

## Magnification Lenses

### OPTIONAL MAGNIFICATION LENSES

- 5x Magnification
- 10x Magnification
- 20x Magnification
- 31<sup>1</sup>/<sub>4</sub>x Magnification
- 50x Magnification
- 62<sup>1</sup>/<sub>2</sub>x Magnification
- 100x Magnification

# 5600

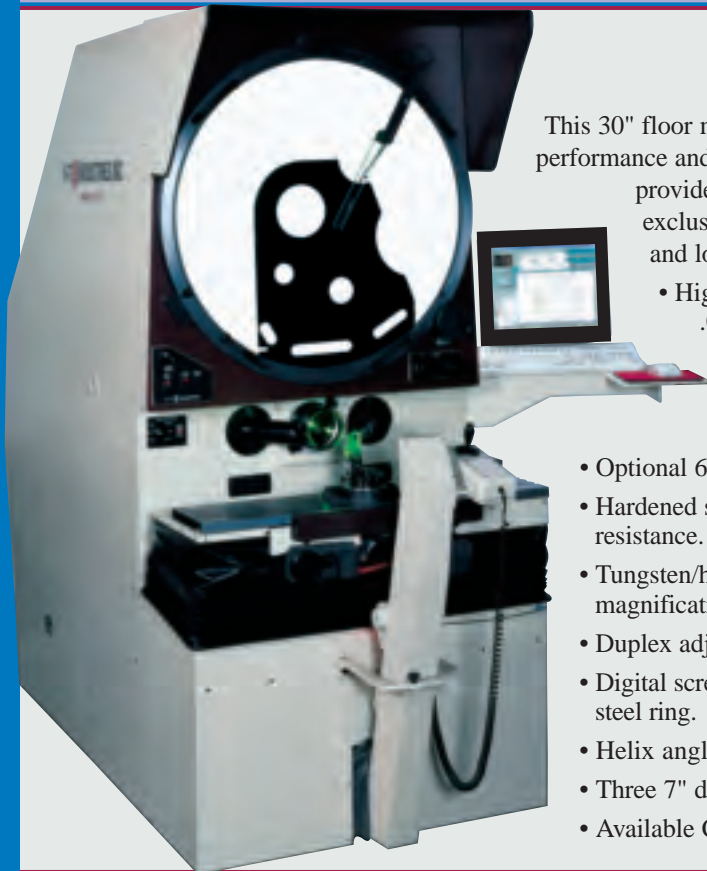

This 30" floor model horizontal beam optical comparator provides the same performance and flexibility as our 2600, except with an erect image. The 5600 provides improved viewing due to its vertical screen. It features S-T's exclusive Gothic arch bearing ways which provide the best in accuracy and longevity.

- High precision 9" x 12" measuring stage travel with .00005"/.001 mm resolution precision glass scales. Optional 7" x 20" and 7" x 24" travels available.
- Motorized X and Y axis with joystick control.
- Choice of all QuadraChek® digital readouts. See page 21.
- Optional 6-position power lens changer.
- Hardened steel, chrome-plated workstage for long life and corrosion resistance.
- Tungsten/halogen profile illumination for bright, sharp images at all magnifications.
- Duplex adjustable surface illumination.
- Digital screen protractor with readings to 1' or .01° with rotating steel ring.
- Helix angle +/- 10° by swinging lamphouse.
- Three 7" diameter wheels for portability.
- Available CNC option.

## Specifications

**Measuring Travel:** 9" x 12" (225 mm x 300 mm)  
Larger travels available  
**Work Table:** 8" x 35", hardened steel, chrome-plated  
**Focus Travel:** 3"  
**Allowable Work Load:** 500 lb  
**Gothic Arch Hardened Steel Bearing Ways**  
**Stage Motion:** Motorized 2-axis variable speed joystick  
**Measuring Stage Resolution:** .00005"/.001 mm  
**Digital Screen Protractor:** 1 min/.01° arc  
**Duplex Adjustable Surface Illumination**  
**30" Frosted Glass Screen:** with 30-, 60- and 90-degree crosslines  
**Helix:** +/- 10° by swinging lamphouse  
**Mounted on Three 7" Wheels for Portability**  
**Electrical:** 115 V, 60 Hz; other voltages available.

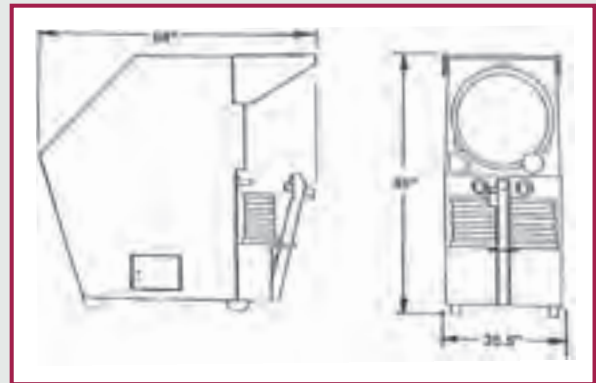

## Magnification Lenses

### OPTIONAL MAGNIFICATION LENSES

- 5x Magnification
- 10x Magnification
- 20x Magnification
- 31<sup>1</sup>/<sub>4</sub>x Magnification
- 50x Magnification
- 62<sup>1</sup>/<sub>2</sub>x Magnification
- 100x Magnification



This is our top-of-the-line 14" benchtop vertical beam optical comparator. The 4600 offers a 4" x 8" measuring stage travel plus an available 4" x 12" option. It features a 3-position lens turret and S-T's exclusive Gothic arch bearing ways which provide the best in accuracy and longevity.

- High precision 4" x 8" or 4" x 12" measuring stage travel with .00005"/.001 mm resolution precision glass scales. Quick release with fine adjust on X-axis.
- Hardened steel, precision ground bearing ways
- Choice of all QuadraChek® digital readouts. See page 21.
- Quick change mount for factory preset magnification lenses in 3-position lens turret.
- Tungsten/halogen profile illumination for bright, sharp images at all magnifications.
- Duplex fiber optic surface illumination.
- Digital screen protractor with readings to 1' or 01°.
- Available with motorized, joystick-controlled stages.
- Available CNC option.

## Specifications

**Work Table:** 10" x 14" (250 mm x 350 mm)  
or 10" x 18" (250 mm x 450 mm)  
**Measuring Range:** 4" x 8" (100 mm x 200 mm)  
or 4" x 12" (100 mm x 300 mm)  
with quick release on X-axis  
**Measuring Stage Resolution:** .00005"/.001 mm  
**Allowable Work Load:** 25 lb  
**Illumination:** Profile - 150 W, Surface - 100 W  
**Focus Travel:** 4"  
**Screen Size:** 14" diameter with 30-, 60- and 90-degree crosslines  
**Digital Screen Protractor:** 1 min./01° arc  
**Floor Space:** 19" x 29"  
**Electrical:** 100/240 V, 50/60 Hz  
**Weight:** 280 lb (127 kg) - Crated 350 lb (160 kg)

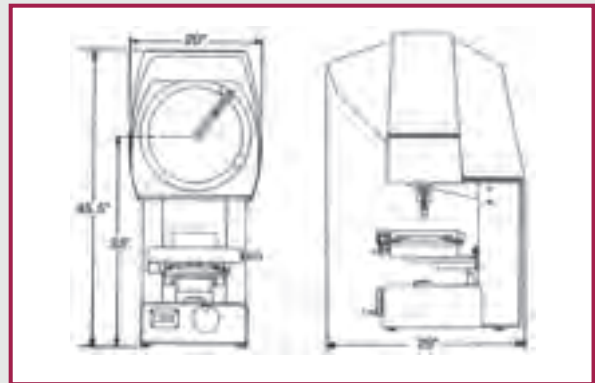

## Magnification Lenses

### OPTIONAL MAGNIFICATION LENSES

- 5x Magnification
- 10x Magnification
- 10x Magnification with long focal distance
- 20x Magnification
- 20x Magnification with long focal distance
- 25x Magnification
- 31<sup>1</sup>/<sub>4</sub>x Magnification
- 50x Magnification
- 62<sup>1</sup>/<sub>2</sub>x Magnification
- 100x Magnification
- 250x Magnification



The "2400" Series 24" floor model vertical beam optical comparator sets a new standard for quality and price. It features a heavy-duty all-steel construction with ultra bright and an extremely sharp image with a built-in 3-lens turret with S-T's exclusive Gothic arch vertical bearings.

- High precision 4" x 8", 4" x 12", 6" x 8" or 6" x 12" travel measuring stages with .00005"/.001 mm resolution precision glass scales. Quick release with fine adjust on x-axis.
- Heavy-duty all-steel construction
- Choice of all QuadraChek® digital readouts. See page 21.
- Hardened steel bearing ways.
- 3-position lens turret.
- Curtain canopy and curtains.
- Digital screen protractor to 1' or .01°.
- Long life tungsten/halogen bulbs.
- Duplex fiber optic surface illumination.
- Available with motorized, joystick-controlled stages.
- Available CNC option.

## Specifications

**Work Table:** 10" x 14" (250 mm x 350 mm), 10" x 18" (250 mm x 450 mm), 12" x 14" (300 mm x 350 mm) or 12" x 18" (300 mm x 450 mm)  
**Measuring Range:** 4" x 8" (100 mm x 200 mm), 4" x 12" (100 mm x 300 mm), 6" x 8" (150 mm x 200 mm) or 6" x 12" (150 mm x 300 mm)  
**Allowable Work Load:** 25 lb (11 kg)  
**Illumination:** Profile - 150 W, Surface - 150 W x 2  
**Digital Screen Protractor:** 1 min/.01° arc  
**Focus Travel:** 4" (100 mm)  
**Screen Size:** 24" (600 mm) with 30-, 60- and 90-degree crosslines  
**Floor Space:** 31" x 47" (785 mm x 1190 mm)  
**Electrical:** 100/240 V, 50/60 Hz  
**Weight:** 450 lb (200 kg) - Crated 500 lb (225 kg)

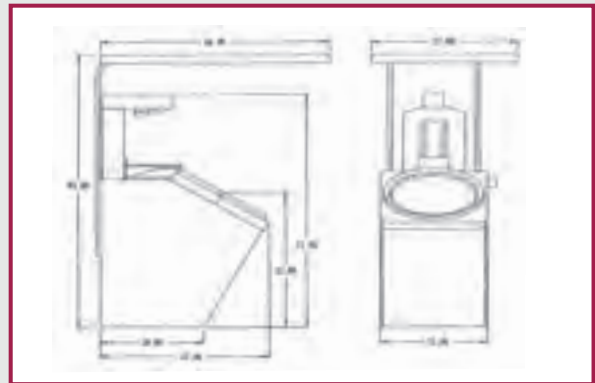

## Magnification Lenses

### OPTIONAL MAGNIFICATION LENSES

- 5x Magnification
- 10x Magnification
- 20x Magnification
- 25x Magnification
- 31<sup>1</sup>/<sub>4</sub>x Magnification
- 50x Magnification
- 62<sup>1</sup>/<sub>2</sub>x Magnification
- 100x Magnification

# REMANUFACTURED 30" COMPARATORS

*Let us "REMANUFACTURE" your SCHERR-TUMICO 30" Comparator for a fraction of the cost of a new one.*



Above: Actual photo of customer's 26-year-old 2600 Series 30" Comparator when received at S-T Industries to be remanufactured.



Above: Actual photo of the same 2600 Series 30" Comparator after being remanufactured at S-T Industries, ready to ship back to the customer.

When S-T Industries remanufactures your 2600 Series 30" Comparator, it is returned to you in "As New Condition" with a certificate to NIST. The remanufactured price includes installation and training at your facility and a new 2-year warranty.

# REMANUFACTURED 30" COMPARATORS

A complete 2500/2600 remanufacture consists of the following:

The customer must send the unit to S-T freight prepaid. We completely strip down the unit, repair any damage to the body, enlarge the side door to current specs, and totally repaint the body to current paint specs. Rebuild the entire stage assembly, regrind or replace the table top and bearing ways, install new bearings, new .00005"/.001 mm Acu-Rite glass scales, new bellows, new surface illuminator assembly, new long-life tungsten halogen bulb assemblies for profile and surface illumination, new protractor ring with digital readout Q axis in DRO, new glass screen, new curtains, replace all required lenses in the lamphouse and replace all electrical components as required. Repair of the magnification lenses is not included in the rebuild.

The remanufactured 2500/2600 unit is as new—it cannot be distinguished from a new unit. The unit is returned to the customer freight collect. Price includes installation and training at the customer's facility and includes a new 2-year warranty.

## REMANUFACTURED COMPARATOR AND DRO

CATALOG NO.	DESCRIPTION
21-2600-01	REMANUFACTURED 2500/2600 WITH QC-121 DRO
21-2600-02	REMANUFACTURED 2500/2600 WITH QC 221
21-2600-03	REMANUFACTURED 2500/2600 WITH QC 221E
21-2600-04	REMANUFACTURED 2500/2600 WITH QC 321E
21-2600-05	REMANUFACTURED 2500/2600 WITH QC 5215
21-2800-01	REMANUFACTURED 2500/2600 WITH QC 5215 CNC

If the unit is to be upgraded from an original tippet and toggle system to the new style joystick system which includes all new electronics, motor control power boards, new lamphouse and joystick with keypad, or if the unit is upgraded with a 6-position power lens changer, see below and price list.

## UPGRADE OPTIONS

CATALOG NO.	DESCRIPTION
21-1700-00	JOYSTICK CONTROL UPGRADE
21-2140-00	6-POSITION POWER LENS CHANGER UPGRADE

**NOTE: On most occasions we have remanufactured units available for sale.**

**NOTE: There is an extra charge to use one of our bodies.**

**NOTE: If you have an old S-T SCHERR-TUMICO 2500/2600 Series 30" Comparator that you are not using and do not intend to use and are interested in selling, regardless of its condition, call us at 1-800-326-2039.**

## Fixtures for Horizontal Beam Comparators

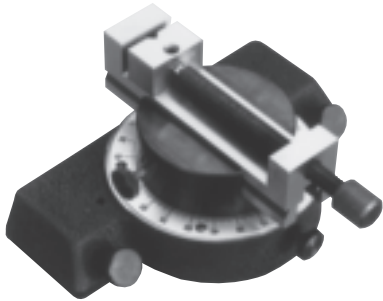

**20-1005-24 Large Rotary Vise**

- Rotates 360° with readings to 1°
- Vise opens to 3.0" x 5/8" deep
- High precision
- For use on 16", 24" and 30" comparators

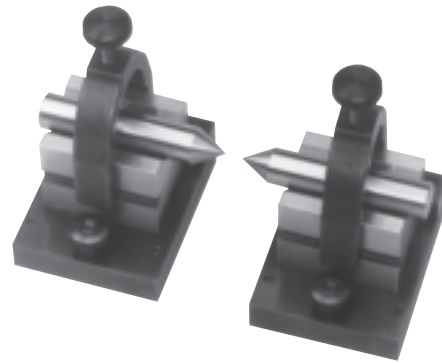

**20-3633-00 Matched V-Blocks with Centers**

- V-Blocks will hold parts up to 1.0" in diameter
- Centers will hold parts up to 3/16" in diameter

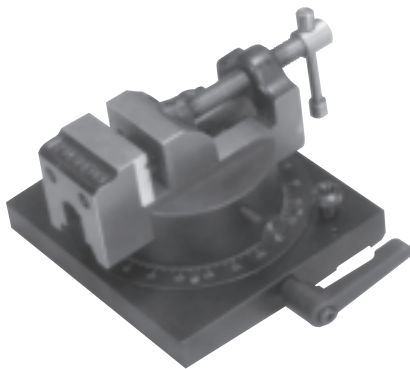

**20-3631-00 Rotary Vise**

- Rotates 360° with readings to 1°
- Vise opens to 1 1/2" x 1.0" deep

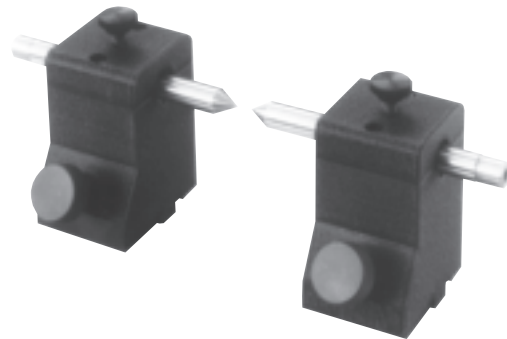

**20-3632-00 Stage Centers**

- Matched pair
- Holds parts up to 5.0" in diameter



**20-3630-00 Rotary V-Block**

- Rotates 360° with readings to 1°
- V-Block holds parts up to 1 1/8" in diameter, including clamp

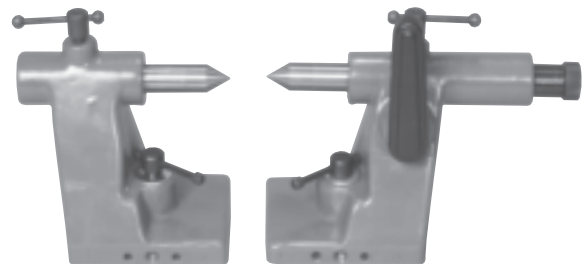

**20-2533-00 Heavy Duty Stage Centers**

- Matched pair
- Holds parts up to 8.0" in diameter
- One stage center is spring-loaded for production inspection

## Fixtures for Horizontal Beam Comparators

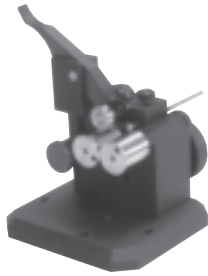

### 20-3623-00 Concentricity Fixture with High Precision Roller

- Rotates round parts up to 1.0" in diameter to check concentricity
- Includes adjustable end stop
- Can be locked to stage to check parts from side or end

### 20-3624-00 Large Concentricity Fixture

- Same as above except holds parts  $\frac{3}{8}$ " to 2.0" in diameter

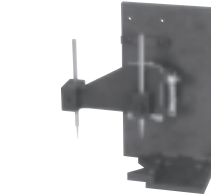

### 20-3523-00 Universal Tracer

- Attachment for use on all sizes of Horizontal Beam Comparators
- One stylus traces the contour of the part and the other stylus is magnified and projected onto the comparator screen and compared to a chart overlay drawing of the part
- Tracer has 2" x 2" of travel with two 0.62" diameter ball styli contacts

\* Top photo is the tracer attachment only

\* Lower photo is the tracer attachment mounted on a "3500" Series 14" Comparator



### 20-2540-00 Vertical Holding Fixture

- Has Plexiglass holding area with spring clips
- Holds parts up to 4 $\frac{1}{2}$ " x 8 $\frac{1}{4}$ " in diameter
- Ideal for thin, flat or flexible parts



### 20-2541-00 Large Vertical Holding Fixture

- Has Plexiglass holding area with spring clips
- Holds parts up to 12" x 10" in diameter



### 20-0390-00 Right Angle Backing Plate

- For use on all Comparators

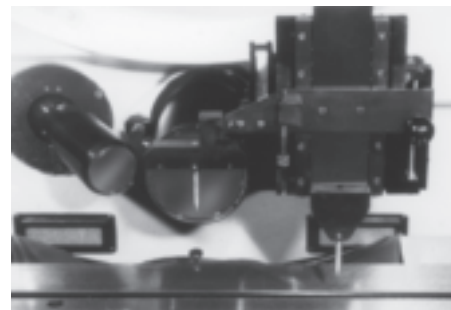

### 22-2535-00 Tracer Attachment for Use on "2600" and "5600" Series 30" Comparators Only

- Tracer mounts to the front of the 30" Comparator
- Tracer has 3" x 3" movement with .125" diameter ball styli contacts

## Fixtures for Vertical Beam Comparators



**20-0390-00 Right Angle Backing Plate**

- For use to position parts square to the stage
- For use on all vertical comparator stages

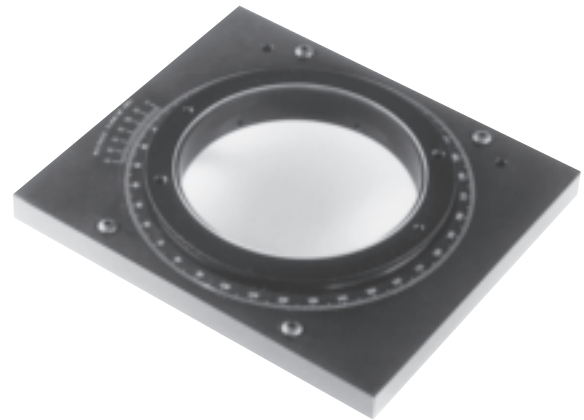

**20-0222-00 Rotary Top Plate**

- Graduated 360°
- Reading to 2' of arc
- For use on all stages

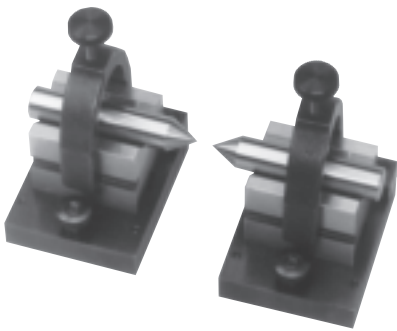

**20-3633-01 Matched V-Blocks with Centers**

- V-Blocks will hold parts up to 1.0" in diameter
- Centers will hold parts up to 3<sup>7</sup>/<sub>16</sub>" in diameter
- For use on all vertical beam comparators



**20-8614-00 Datum Bar**

- For use on 4" x 8" & 6" x 8" travel stages to position parts square to the stage

**20-8614-05 Datum Bar**

- Same as above except for 4" x 12", 6" x 12" & 12" x 12" travel stages

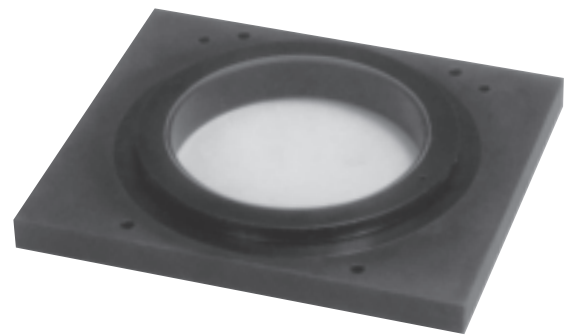

**20-0222-01 Rotary Top Plate with No Graduations**

- Rotates 360°
- For use on all stages

# SCREENS AND CHARTS

## SEALED IMAGE® Comparator Charts and Screens

ALL CHARTS AND SCREENS FEATURE THE SEALED IMAGE PROCESS

The **Sealed Image** process was developed to give maximum life to our precision charts and screens. A thin sheet of vinyl plastic is laminated over the artwork, thereby protecting the image from wearing off due to use or cleaning.

The lines on charts are made accurate to their center unless otherwise stated on the chart. Our basic line width is .004 to .005 (.1 mm to .12 mm).

Glass screens are used for new or replacement screens for optical comparators. The image is centered to the OD of the glass to .005". Glass screens are available only for 14", 16", 24" and 30" S-T Industries, Inc./SCHERR-TUMICO optical comparators. Glass screens are recommended when the artwork pattern will be used for all applications.

Plastic overlay charts are recommended when patterns will be changed frequently. Plastic charts are available in any diameter up to 30" (760 mm). The plastic material is dimensionally stable, non-flammable and resistant to oil. To avoid distortion, plastic overlay charts should not be stored above 140°F (60°C).

Cleaning - Clean Sealed Image charts and screens with glass cleaner, soap and water or isopropanol using a soft cotton cloth. Avoid harsh rubbing. Do not use paper towels or coarse cloths and do not use acetone, benzene, lacquer thinner or other strong chemicals as they will damage the surface.

To order glass and plastic charts, use this part number format:



Example: 20X Radial/Gold Glass Screen for 14" Optical Comparator = 74-0031-1425

**IMPORTANT** - When ordering glass replacement screens, please include the model number of your optical comparator.

**SPECIAL ARTWORK** - Custom artwork is available on request. We can combine standard patterns or produce custom artwork scaled from your drawings.

**NIST CERTIFICATIONS** - Accuracy certifications can be provided at an additional charge. Please request this at the time your order is placed.

## CENTERLINE SCREENS

STANDARD GLASS CENTERLINE SCREENS ARE BASIC FOR ANY OPTICAL COMPARATOR.



74-0008

## CENTERLINE SCREENS

STANDARD GLASS CENTERLINE SCREENS ARE BASIC FOR ANY OPTICAL COMPARATOR.

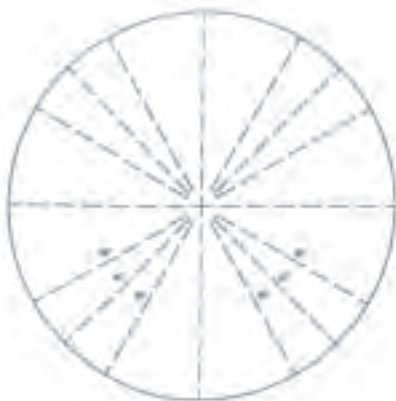

74-0073



74-0062

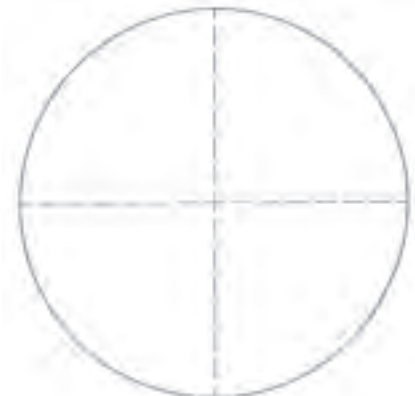

74-0060

# SCREENS AND CHARTS

## COMBINATION MAGNIFICATION-RADIUS CHARTS

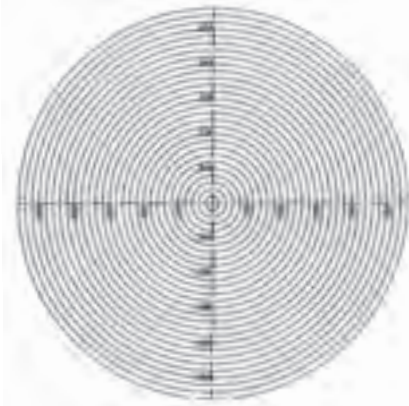

CATALOG NO.	MAG.	INCREMENTS
74-0004	10x	.002"
	20x	.0025"
	30x	.001"
74-0008	10x	.010"
	20x	.005"
74-0008	31 1/2x	.002"
	62 1/2x	.001"

Other combinations available on request.

## COMBINATION RADIUS-GRID CHARTS



CATALOG NO.	MAG.	INCREMENTS
74-0030	10x	.005"
74-0031	20x	.0025"
74-0034	50x	.001"
74-0036	100x	.0005"

Other magnifications and increments available on request.

## RADIUS CHARTS

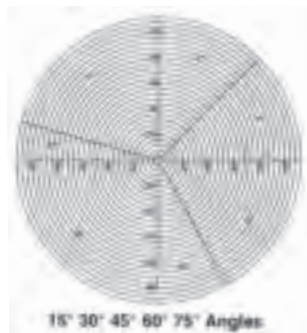

CATALOG NO.	MAG.	INCREMENTS
74-0102	5x	.010"
74-0100	10x	.005"
74-0101	20x	.0025"
74-0103	31 1/2x	.002"
74-0104	50x	.001"
74-0106	62 1/2x	.001"
74-0108	100x	.0005"
74-0102	10x	.10mm
74-0103	20x	.05mm
74-0104	50x	.02mm
74-0105	100x	.01mm

Other magnifications and increments available on request.

## GRID CHARTS

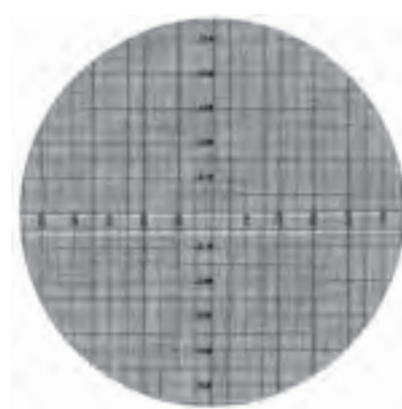

CATALOG NO.	MAG.	INCREMENTS
74-0010	10x	.001"
74-0011	20x	.0005"
74-0013	31 1/2x	.002"
74-0014	50x	.001"
74-0015	62 1/2x	.001"
74-0016	100x	.0005"

Other magnifications and increments available on request.

# SCREENS AND CHARTS

## 180° RADIUS CHARTS with 30° and 45° Angles



CATALOG NO.	MAG.	INCREMENTS
74-0481	10x	.011"
74-0482	20x	.005"
74-0483	25x	.004"
74-0484	31 1/2x	.004"
74-0485	50x	.003"
74-0486	62 1/2x	.003"
74-0487	100x	.001"

Other angle lines, increments and combination magnifications available on request.

## THREAD CHARTS

ALL THREAD CHARTS ARE FOR CHECKING THE THREAD ANGLE, ROOT AND CREST FORMS AND DEPTH.



CATALOG NO.	THREAD TYPE
74-0488	American National, 4 to 80 pitch threads
74-0489	Unified basic, 4 to 80 pitch threads
74-0490	ISO Metric, .25 to 6.0 mm pitch threads
74-0491	UNJ Basic, MIL., Spec 8879A 4 to 80 pitch threads
74-0493	American National Taper pipe threads

**NOTE:** You must specify magnification lens being used on your comparator.

## GLASS PROTRACTOR SCREENS

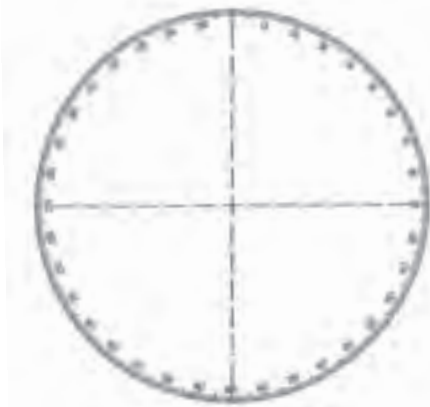

CATALOG NO.	DEGREE INCREMENTS
74-0053	0-360 degrees marked every 5 degrees, graduated every 30 minutes

Available in other increments and available in combination of radius, grid, combination radius-grid and thread charts on request.

## SPECIAL CHARTS



Our engineering staff is available to assist you in developing special charts tailored to your specifications. They can be printed in any size or configuration.

# COMPARATOR CALIBRATION KITS



## 74-0413-00

- Master magnification ball checker
- In wood case and certificate to NIST
- For use on all sizes and types of comparators



## 74-0321-10

- 10" glass magnification scale
- With knobs, wood case and certificate to NIST
- For 12" through 16" comparators



## 74-0330-20

- 20" glass magnification scale
- With knobs, wood case and certificate to NIST
- For 24" and larger comparators

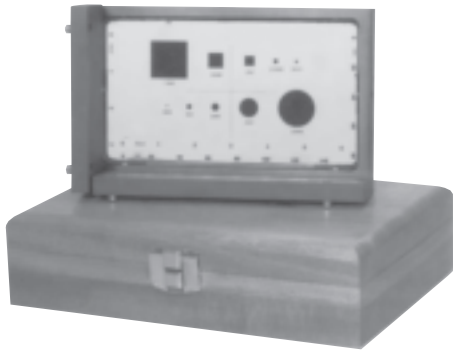

## 74-0500-00

- Stage calibration master for checking X & Y linear accuracy and squareness of stage
- Includes wood case and certificate to NIST
- For all sizes and types of comparators
- Measuring range, 4" x 6", English and metric



## 74-0501-00

- 12" long, English and metric
- Stage calibration master for checking linear stage accuracy
- Includes wood case and certificate to NIST
- For use on all comparators

# CONSOLE BASES

## **HEAVY-DUTY CONSOLE BASE FOR 3500, 3700, 1600 AND 4600 SERIES OPTICAL COMPARATORS**



**20-1406-00**  
Heavy-duty all-steel  
console with front door and  
four adjustable leveling pads.

## **STANDARD CONSOLE BASE FOR 3500, 3700 AND 4600 SERIES OPTICAL COMPARATORS**



**20-1411-00**  
All-steel construction  
with laminated top and  
four adjustable leveling pads.

**20-1412-00**  
Optional Locking Drawer  
Can be easily installed  
at a later date.

# LENS FOCAL CLEARING CHART

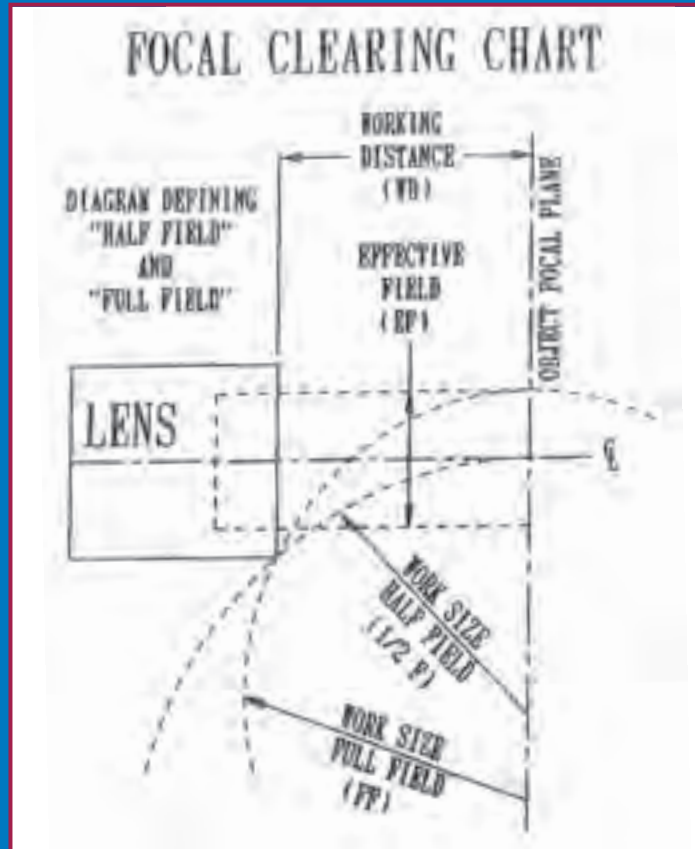

## All 14" Comparators

MAG.	WD	EF	DIA 1/2F	DIA FF
5X	1.80" (45.7 mm)	2.80" (71.1 mm)	3.60" (91.4 mm)	3.60" (91.4 mm)
10X	2.70" (68.6 mm)	1.40" (35.6 mm)	8.30" (210.8 mm)	6.00" (152.4 mm)
*10X				
20X	1.25" (31.8 mm)	0.70" (17.8 mm)	3.20" (81.3 mm)	2.60" (66.0 mm)
*20X	3.13" (79.5 mm)	0.70" (17.8 mm)	6.79" (172.5 mm)	4.84" (122.9 mm)
25X	2.75" (69.9 mm)	0.56" (14.2 mm)	5.14" (130.6 mm)	4.07" (103.4 mm)
31 1/4X	2.00" (50.8 mm)	0.87" (22.1 mm)	2.90" (73.7 mm)	2.23" (56.6 mm)
50X	2.50" (63.5 mm)	0.28" (7.1 mm)	9.20" (233.7 mm)	8.40" (213.4 mm)
62 1/2X	2.90" (73.7 mm)	0.22" (5.6 mm)	9.20" (233.7 mm)	9.20" (233.7 mm)
100X	1.00" (25.4 mm)	0.14" (3.6 mm)	3.20" (81.3 mm)	2.80" (71.1 mm)
250X	.59" (15.0 mm)	0.06" (1.5 mm)	1.40" (35.6 mm)	1.30" (33.0 mm)

\*SPECIAL 10X AND 20X LENS WITH EXTRA LONG WORKING DISTANCES

## All 16" Comparators

MAG.	WD	EF	DIA 1/2F	DIA FF
5X				
10X	3.15" (80 mm)	1.6" (41 mm)	9.7" (246 mm)	7.0" (178 mm)
20X	3.23" (82 mm)	0.8" (20 mm)	14.0" (356 mm)	9.9" (251 mm)
25X	2.76" (70 mm)	0.64" (16 mm)	10.4" (264 mm)	7.9" (201 mm)
31 1/4X				
50X	2.09" (53 mm)	0.32" (8 mm)	7.9" (201 mm)	6.5" (165 mm)
62 1/2X				
100X	1.69" (43 mm)	0.16" (4 mm)	5.4" (137 mm)	4.9" (124 mm)

## All 24" Comparators

MAG.	WD	EF	DIA 1/2F	DIA FF
5X				
10X	5.4" (137 mm)	2.4" (61 mm)	18.3" (465 mm)	13.8" (351 mm)
20X	5.4" (137 mm)	1.2" (30 mm)	17.9" (455 mm)	17.9" (455 mm)
25X	4.7" (119 mm)	1.0" (25 mm)	18.3" (465 mm)	15.0" (381 mm)
31 1/4X				
50X	3.9" (99 mm)	0.5" (13 mm)	16.6" (422 mm)	14.9" (378 mm)
62 1/2X				
100X	1.9" (48 mm)	0.24" (6 mm)	5.6" (142 mm)	5.0" (127 mm)

## All 30" Comparators

MAG.	WD	EF	DIA 1/2F	DIA FF
5X	4.8" (122 mm)	6.0" (152 mm)	10.1" (256 mm)	9.9" (251 mm)
10X	6.5" (165 mm)	3.0" (76 mm)	20.3" (516 mm)	15.5" (394 mm)
20X	4.4" (112 mm)	1.5" (38 mm)	15.4" (391 mm)	13.5" (343 mm)
31 1/4X	3.2" (81 mm)	1.0" (25 mm)	10.0" (254 mm)	7.9" (201 mm)
50X	2.4" (61 mm)	0.6" (15 mm)	8.0" (203 mm)	6.3" (160 mm)
62 1/2X	2.1" (53 mm)	0.5" (13 mm)	6.4" (163 mm)	5.3" (135 mm)
100X	1.8" (46 mm)	0.3" (8 mm)	6.4" (163 mm)	5.4" (137 mm)

# QUADRA CHEK® DIGITAL READOUTS



## STANDARD DIGITAL READOUT QUADRA-CHEK® 120 (100)

The Standard digital readout features absolute/incremental, IN/MM conversion, random zeroing, RS232C output and linear error compensation.



## Quadra-Chek® 220

This powerful digital readout provides fast geometric computations in a simple, easy-to-use format. Functions include point, line, circle, distance, angle, skew alignment and Measure Magic. Other features include Inch/MM, Cartesian/Polar, nearest/farthest distance, complementary angles, serial and parallel ports and 200-feature memory. Large, high-contrast LCD screen graphically displays measurement features and construction. Housing tilts backward or forward for best angle of operation.

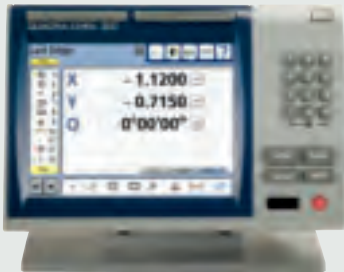

## Quadra-Chek® 320

The QC 320 features a touch screen, high-resolution color display. Its functions include all the same standard geometric features as QC-220 Series; part programming and reporting.

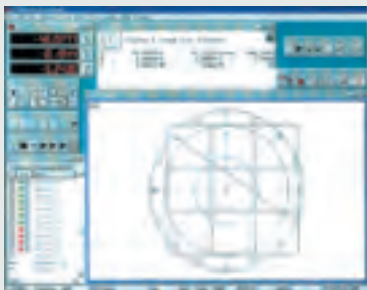

## Quadra-Chek® 5000

PC computer-based geometric readout system is mouse-driven with on-screen graphic representation of part or part segment as it is measured. Simple CAD interface simplifies constructions and part programming. Unlimited part and feature memory. Includes computer with Microsoft® Windows®, fiber optic edge sensor and all functions found in the Quadra-Chek 200.

### S-T OPTICAL COMPARATOR SPECIFICATION GUIDE

Standard Series No.	3500	3700	1600	4600	2400	2450	2460	2600	5600
CNC Series No.	N/A	3788	1680	4800	2480	2488	2468	2800	5800
<b>SCREEN DIAMETER</b>	14"	14"	16"	14"	24"	24"	24"	30"	30"
<b>PROFILE ILLUMINATION</b>	Horizontal	Horizontal	Horizontal	Vertical	Vertical	Horizontal	Horizontal	Horizontal	Horizontal
<b>IMAGE</b>	Inverted	Erect	Erect	Erect	Erect	Erect	Inverted	Inverted	Erect
<b>WORKSTAGES</b>									
Workstage Size	5" x 16"	5" x 20"	5" x 20"	10" x 14"	10" x 14"	5" x 24"	5" x 24"	8" x 35"	8" x 35"
<b>WORKSTAGE TRAVEL</b>									
X-Axis	10" (250 mm)	12" (300 mm)	12" (300 mm)	8" (200 mm)	8" (200 mm)	12" (300 mm)	12" (300 mm)	12" (300 mm)	12" (300 mm)
Y-Axis	4" (100 mm)	6" (150 mm)	7" (175 mm)	4" (100 mm)	4" (160 mm)	8" (200 mm)	8" (200 mm)	9" (225 mm)	9" (225 mm)
Stage Workload Capacity	50 lb	100 lb	150 lb	25 lb	25 lb	200 lb	200 lb	500 lb	500 lb
Helix Adjustment	+/- 6°	+/- 6°	+/- 15°	N/A	N/A	+/- 15°	+/- 15°	+/- 10°	+/- 10°
<b>OPTIONAL STAGES</b>									
Workstage Size	N/A	5" x 20"	5" x 24"	10" x 18"	10" x 18"	5" x 24"	5" x 24"	8" x 35"	8" x 35"
<b>WORKSTAGE TRAVEL</b>									
X-Axis	N/A	16"	16"	12"	12"	16"	16"	20" or 24"	20" or 24"
Y-Axis	N/A	5"	7"	4"	6"	8"	8"	7"	7"
Stage Workload Capacity	N/A	100 lb	150 lb	15 lb	15 lb	150 lb	150 lb	500 lb	500 lb
<b>READOUTS</b>									
QC 120	S	S	S	S	S	S	S	S	S
QC 220/221	0	0	0	0	0	0	0	0	0
QC 220E/221E w/edge sensor	0	0	0	0	0	0	0	0	0
QC 321E w/ edge sensor	0	0	0	0	0	0	0	0	0
QC 5215 w/edge sensor	0	0	0	0	0	0	0	0	0
<b>OPTIONS</b>									
Surface Illumination	S	S	S	S	S	S	S	S	S
Digital Screen Protractor	0	S	S	S	S	S	S	S	S
Power X-Y Axis/Joystick	N/A	0	0	0	0	S	S	S	S
Turret Lens Changer	N/A	S	0	S	S	S	N/A	0	0
Iris Diaphragm	0	0	0	0	0	0	0	S	S
Green Filter	0	0	0	0	0	0	0	S	S
<b>MAGNIFICATION LENSES</b>									
Full Range of Mag. Lenses 10X, 20X, 25X, 31 <sup>1</sup> / <sub>4</sub> X, 50X									
62 <sup>1</sup> / <sub>2</sub> X, 100X	0	0	0	0	0	0	0	0	0
5X Magnification Lens	0	0	0	0	0	0	0	0	0
250X Magnification Lens	0	0	N/A	0	N/A	N/A	N/A	N/A	N/A
<b>ACCESSORIES</b>									
Stage Centers	0	0	0	0	0	0	0	0	0
Rotary Vise	0	0	0	N/A	N/A	0	0	0	0
V-Blocks w/Centers	0	0	0	0	0	0	0	0	0
Rotary V-Blocks	0	0	0	N/A	N/A	0	0	0	0
Rotary Top Plate	N/A	N/A	N/A	0	0	N/A	N/A	N/A	N/A
Glass Plate Workholder	0	0	0	N/A	N/A	0	0	0	0
Tracer Attachment	0	0	0	N/A	N/A	0	0	0	0



# RFM

Resources For Manufacturing, Inc.

P.O. Box 751432 Dayton, OH 45475

Ph: (937) 436-4699 Fx: (937) 436-9244

Sales@RFMInc.net www.RFMInc.net

All S-T Industries Optical Comparators include a two-year warranty on parts and labor, installation and training at your facility and a certificate to NIST. There are no additional hidden costs for this service.

